

CATENE PER ACCUMULO



ROSA

**EURO
CATENE**

INDICE

CATENE PER ACCUMULO

Glossario delle principali abbreviazioni utilizzate nel catalogo	1
Catena semplice con un rullo folle superiore	2
Catena semplice con due rulli superiori folli	5
Catena doppia con due o quattro rulli superiori folli	5
Catena tripla con rullo folle centrale	6
Catena con rullo folle centrale (tipo largo)	7
Catena semplice con tre rulli folli superiori	8
Catena a tre rulli folli per trasportatori ad accumulazione	9
Catena tripla con rullo folle laterale	10
Catene con rullo folle laterale	11
Parti staccate per catene a rulli	13

INDEX

ACCUMULATION CHAINS

<i>Glossary of the main abbreviations used in the catalog</i>	1
<i>Single chain with one superior fly roller</i>	2
<i>Single chain with two superior fly rollers</i>	5
<i>Double chain with two or four superior fly rollers</i>	5
<i>Triple chain with central fly roller</i>	6
<i>Chain with central large fly roller</i>	7
<i>Single chain with three superior fly rollers</i>	8
<i>Accumulations chains</i>	9
<i>Triple chain with lateral fly roller</i>	10
<i>Chains with lateral fly roller</i>	11
<i>Loose parts for roller chains</i>	13

La ROSA CATENE spa e la EUROCATENE sas declinano qualsiasi responsabilità per eventuali errori in cui possono essere incorse nella compilazione del presente catalogo e si riservano il diritto di apportare, al disegno ed alle dimensioni dei prodotti descritti, qualsiasi modifica richiesta dallo sviluppo evolutivo dei suddetti prodotti.

In accordance with the policies of ROSA CATENE spa and EUROCATRENE sas to constantly improve their products, the specifications in this catalog are subject to change without notice.

GLOSSARIO

p	=	Passo
Hi	=	Larghezza interna della maglia interna (min)
Dr	=	Diametro del rullo
Hp	=	Altezza della piastra (max)
s	=	Spessore della piastra
Sj	=	Spessore della piastra interna
Se	=	Spessore della piastra esterna
Dp	=	Diametro del perno (max)
l	=	Lunghezza del perno ribadito (max)
lx	=	Ingombro massimo sulla giunzione
pt	=	Passo trasversale
Db	=	Diametro della bussola (max)
Df	=	Diametro del foro del perno forato
R	=	Raggio minimo di curvatura

GLOSSARY

p	=	Pitch
Hi	=	Inside width (min)
Dr	=	Roller diameter
Hp	=	Sidebar height (max)
s	=	Plate thickness
Sj	=	Inner plate thickness
Se	=	Outer plate thickness
Dp	=	Pin diameter (max)
l	=	Riveted pin width (max)
lx	=	Maxim overall width
pt	=	Gauge
Db	=	Bushing diameter (max)
Df	=	Bore pin diameter
R	=	Minimum bending radius



CATENA SEMPLICE CON UN RULLO FOLLE SUPERIORE

SINGLE CHAIN WITH ONE SUPERIOR FLY ROLLER

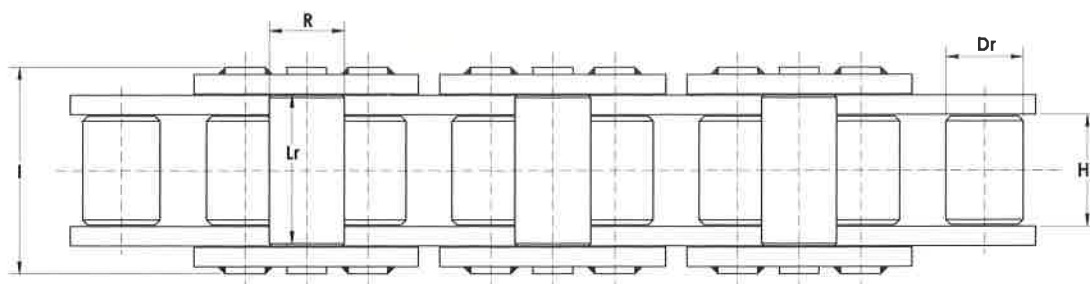
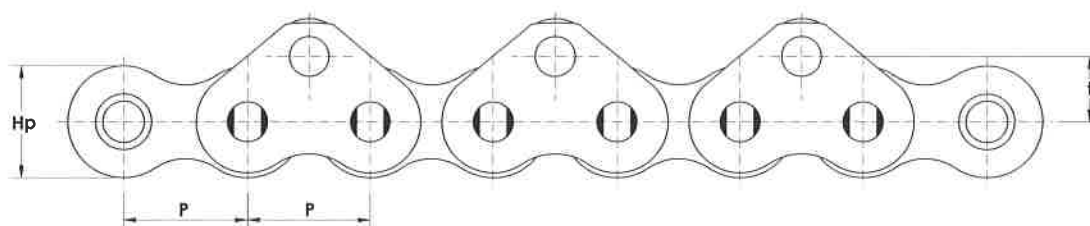

NOSTRO CODICE	passo	largh. interna	diam. rullo	altezza piastra	ingombro perno	diam. rullo folle	larghezza rullo folle	interasse verticale	Carico minimo di rottura	TRADE MARK
	P mm	Hi mm	Dr mm	Hp mm	l mm	R mm	Lr mm	t mm		
1435/ACC	25,40	17,02	15,88	21,0	35,0	30	24	26	6.500	
1475/ACC	31,75	19,56	19,05	27,2	42,0	20	28	19	8.500	

CATENA SEMPLICE CON UN RULLO FOLLE SUPERIORE
SINGLE CHAIN WITH ONE SUPERIOR FLY ROLLER

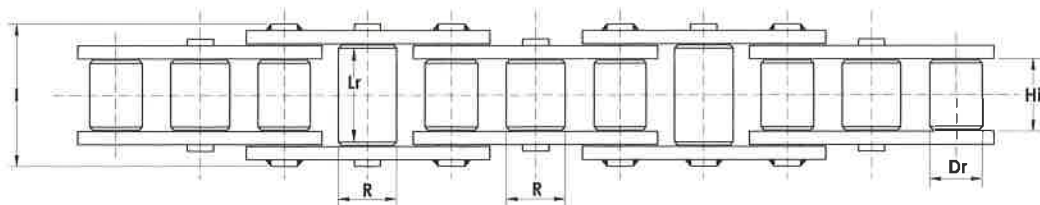
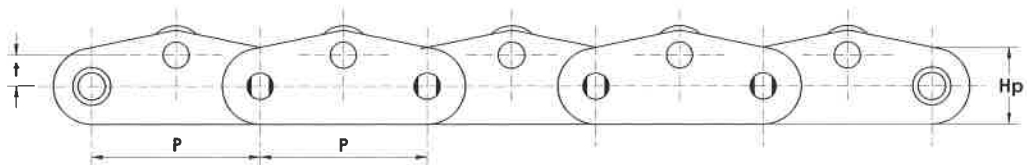

NOSTRO CODICE	passo	largh. interna	diam. rullo	altezza piastra	ingombro perno	diam. rullo folle	larghezza rullo folle	interasse verticale	Carico minimo di rottura Kg	TRADE MARK
	P mm	Hl mm	Dr mm	Hp mm	I mm	R mm	Lr mm	t mm		
5026/ACC	50	26	20	25	47	24	33	10	4.200	EURO CATENE

CATENA SEMPLICE CON UN RULLO FOLLE SUPERIORE

SINGLE CHAIN WITH ONE SUPERIOR FLY ROLLER

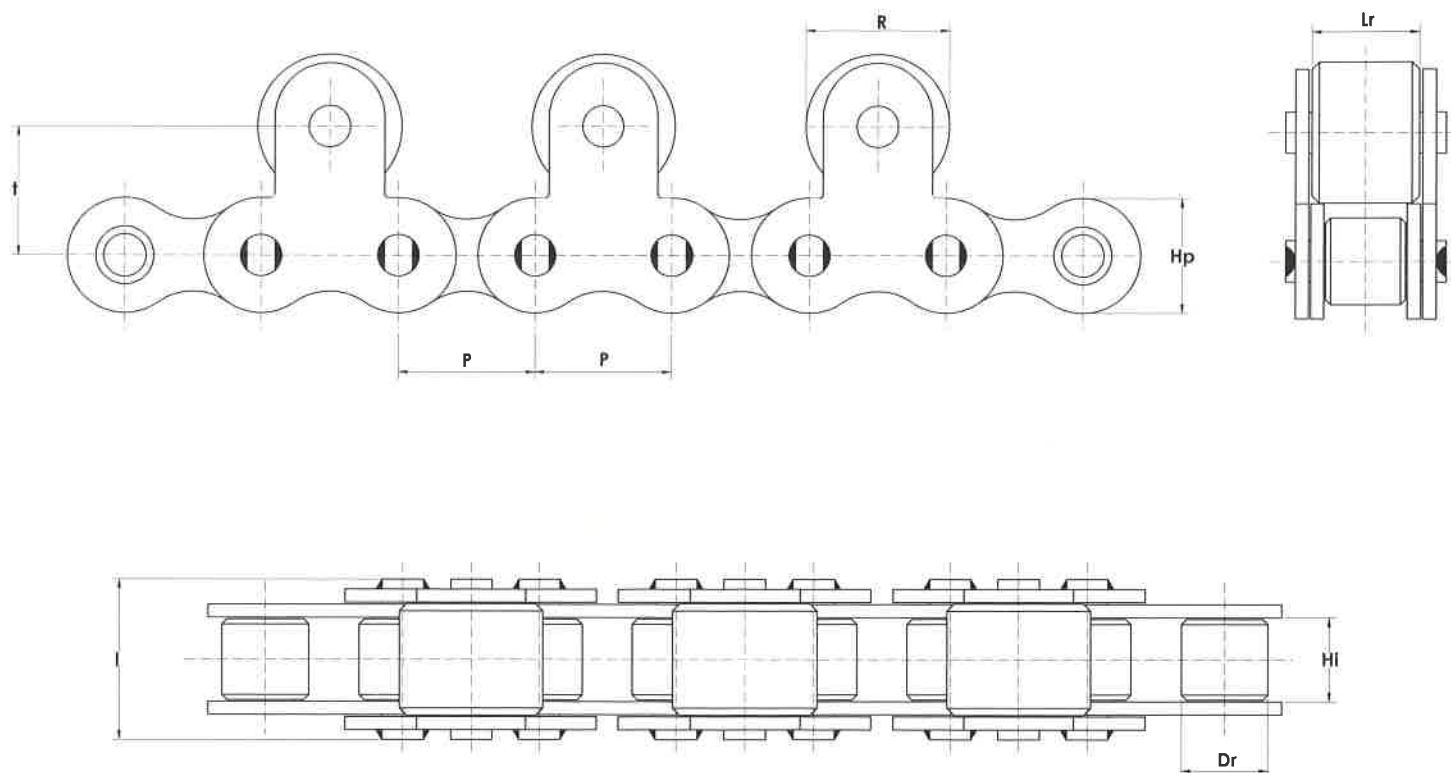

NOSTRO CODICE	passo	largh. interna	diam. rullo	altezza piastra	ingombro perno	diam. rullo folle	larghezza rullo folle	interasse verticale	Carico minimo di rottura	TRADE MARK
	P mm	Hi mm	Dr mm	Hp mm	I mm	R mm	Lr mm	↑ mm		
E388/ACC	9,525	5,72	6,35	8,26	13,50	12	8,3	10,2	1.000	
E516/ACC	12,70	7,75	8,51	11,90	16,50	15	10,7	14,5	1.900	
E583/ACC	15,875	9,65	10,16	14,73	19,60	20	13,2	18,8	2.500	
E716/ACC	19,05	11,68	12,07	16,13	22,30	20	15,5	*19,5	3.000	
E143/ACC	25,40	17,02	15,88	21,00	35,00	23	24,0	23,6	6.500	

* Disponibile anche 17,90 / Available also 17,90

CATENA SEMPLICE CON DUE RULLI SUPERIORI FOLLI

SINGLE CHAIN WITH TWO SUPERIOR FLY ROLLERS

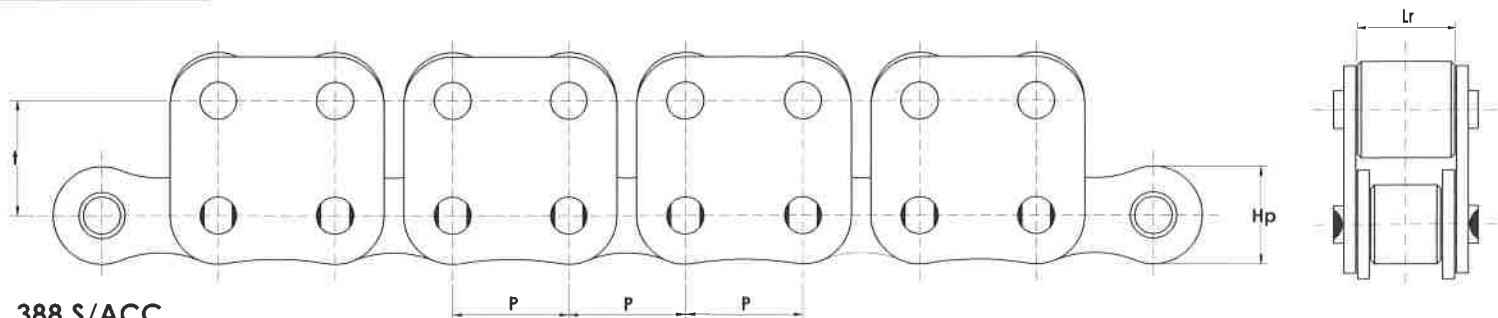

388 S/ACC
516 S/ACC
583 S/ACC
716 S/ACC

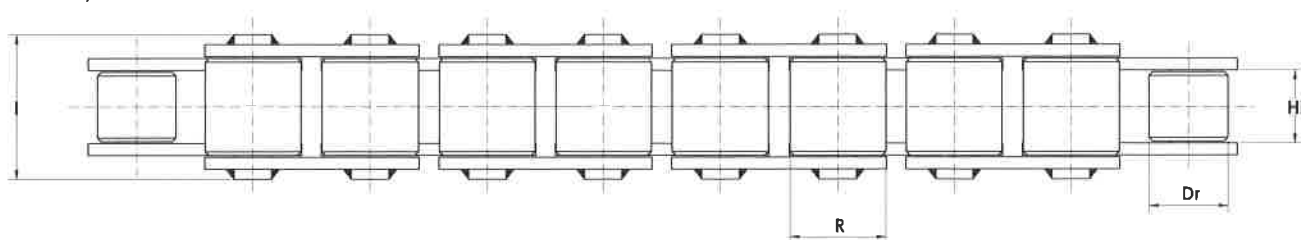

CATENA DOPPIA CON DUE O QUATTRO RULLI SUPERIORI FOLLI

DOUBLE CHAIN WITH TWO OR FOUR SUPERIOR FLY ROLLERS

TIPO A 4 RULLI FOLLI - TYPE WITH 4 FLY ROLLERS

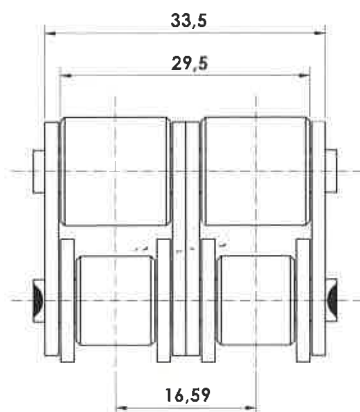

583 D/ACC/A

TIPO A 2 RULLI FOLLI - TYPE WITH 2 FLY ROLLERS

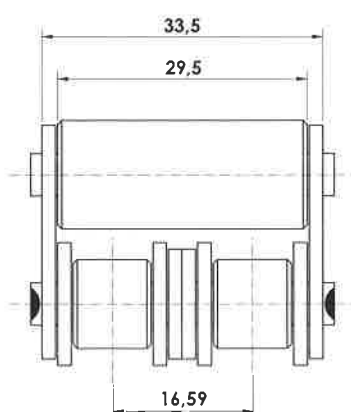

583 D/ACC/B

NOSTRO CODICE	passo	largh. interna	diam. rullo	altezza piastra	ingombro perno	diam. rullo folle	larghezza rullo folle	interasse verticale	Carico minimo di rottura Kg	TRADE MARK
	P mm	Hi mm	Dr mm	Hp mm	I mm	R mm	Lr mm	† mm		
388S/ACC	9,525	5,72	6,35	8,26	13,2	8	8,3	10,0	1.000	
516S/ACC	12,70	7,75	8,51	11,90	17,0	12	10,7	13,2	1.900	
583S/ACC	15,875	9,65	10,16	14,73	20,2	13	13,8	15,5	2.500	
583D/ACC/A	15,875	9,65	10,16	14,73	36,0	13	13,8	15,5	5.000	
583D/ACC/B	15,875	9,65	10,16	14,73	36,0	13	29,5	15,5	5.000	
716S/ACC	19,05	11,68	12,07	16,13	22,3	18	15,5	19,0	3.000	

CATENA TRIPLA CON RULLO FOLLE CENTRALE

TRIPLE CHAIN WITH CENTRAL FLY ROLLER

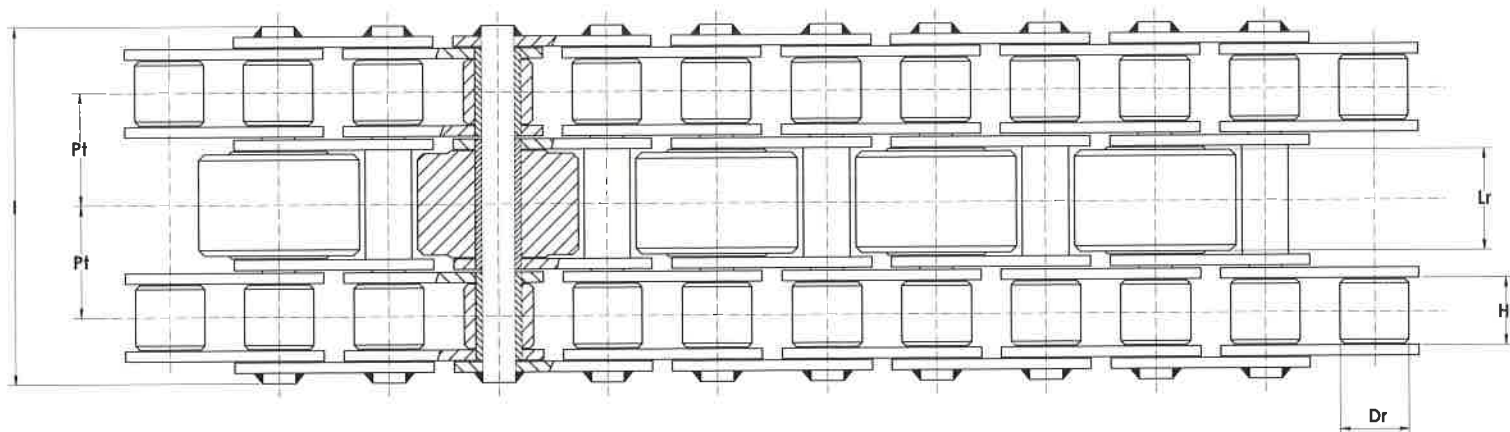
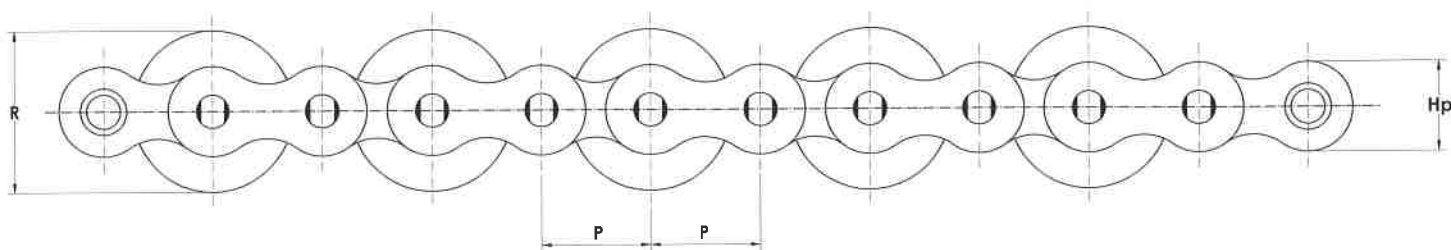

NOSTRO CODICE	passo	largh. interna	diam. rullo	altezza piastra	passo trasversale	ingombro perno	diam. rullo folle	larghezza rullo folle	Carico minimo di rottura	TRADE MARK
	P mm	Hi mm	Dr mm	Hp mm	Pt mm	l mm	R mm	Lr mm	Kg	
388TB/ACC	9,525	5,72	6,35	8,26	10,24	34	12	9,0	1.900	
516TB/ACC	12,70	7,75	8,51	11,90	13,92	45	17	13,5	3.600	
583TB/ACC	15,875	9,65	10,16	14,73	16,59	54	23	16,3	5.000	
716TB/ACC	19,05	11,68	12,07	16,13	19,46	62	28	18,6	6.000	
143TB/ACC	25,40	17,02	15,88	21,00	31,88	99	35	31,5	13.200	
152TB/ACC	38,10	25,40	25,40	33,00	48,36	152	45	45,0	29.000	

CATENA CON RULLO FOLLE CENTRALE (tipo largo)

CHAIN WITH CENTRAL LARGE FLY ROLLER

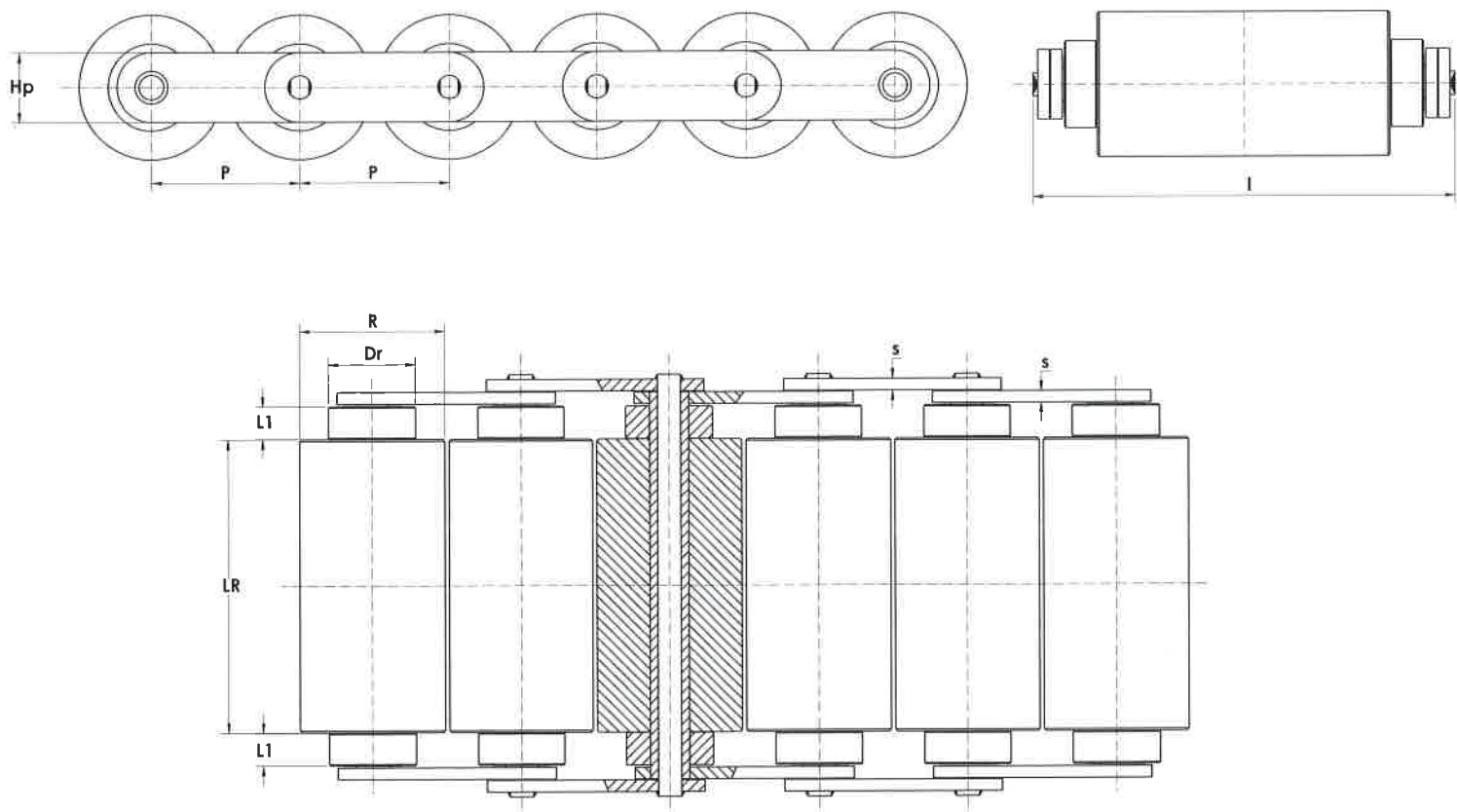

NOSTRO CODICE	passo	diametro rullo piccolo	diametro rullo grande	larghezza rullo piccolo	larghezza rullo grande	altezza max piastre	spessore piastre	ingombro perno	Carico minimo di rottura	TRADE MARK
	P mm	Dr (*) mm	R (*) mm	L1 mm	LR mm	Hp mm	s mm	I mm	Kg	
C2062RL/ACC	38,10	22,23	37	8,35	75	18,08	3	108	3.800	

(*)Rulli in plastica / Plastic Rollers

A richiesta possono essere variate le larghezze e il materiale dei rulli / On request chains can be supplied with different widths and/or material

CATENA SEMPLICE CON TRE RULLI FOLLI SUPERIORI

SINGLE CHAIN WITH THREE SUPERIOR FLY ROLLERS

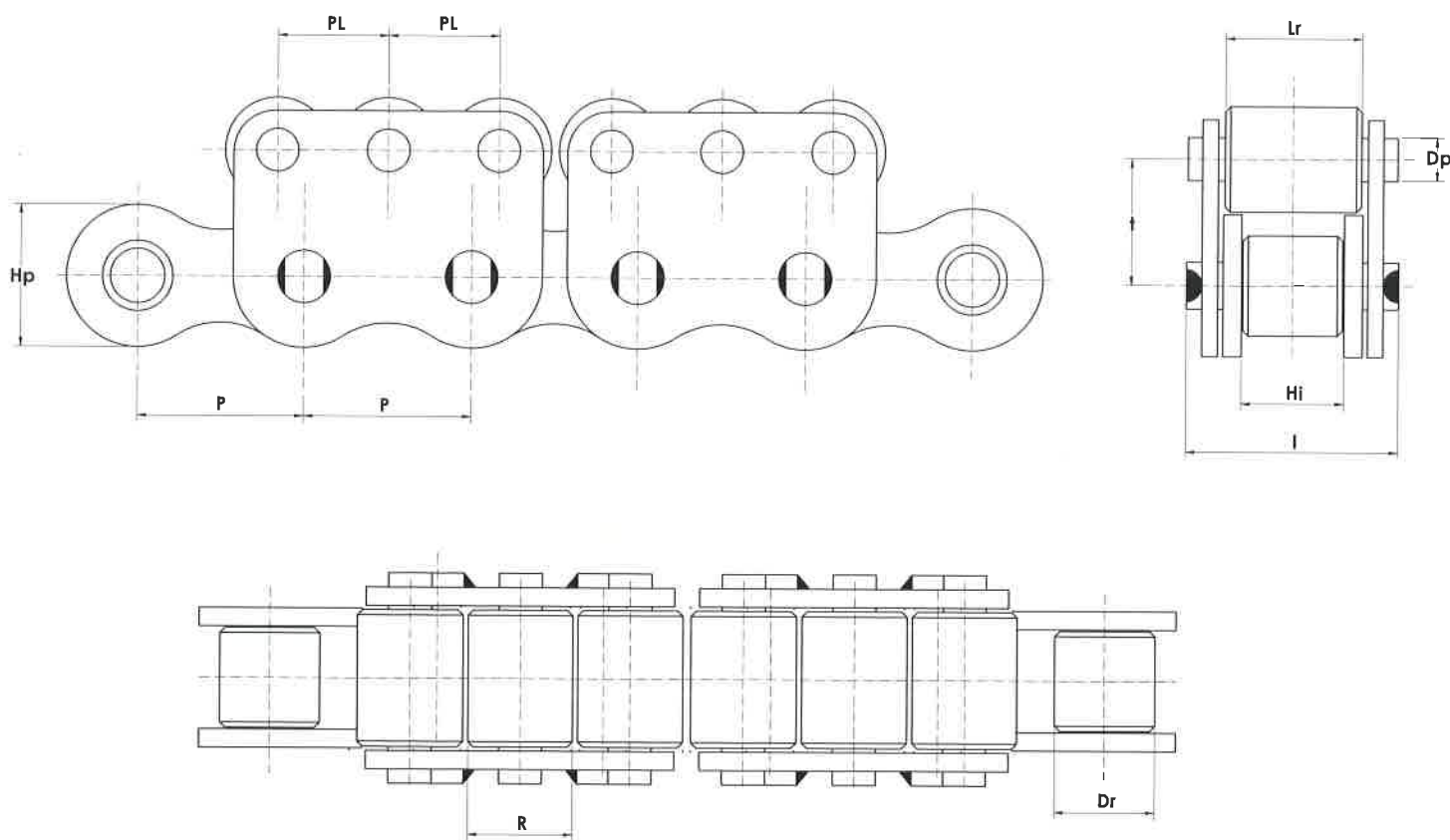

NOSTRO CODICE	passo	largh. interna	diam. rullo	altezza piastra	ingombro perno	diam. rullo folle	larghezza rullo folle	interasse verticale	interasse longitud.	diam. perno sup.	Carico minimo di rottura	TRADE MARK
	P mm	Hi mm	Dr mm	Hp mm	I mm	R mm	Lr mm	f mm	Pl mm	Dp1 mm		
143E/ACC	25,40	17,02	15,88	21,0	35,00	15	24	19,9	16,5	5,05	6.500	
147E/ACC	31,75	19,56	19,05	27,0	40,50	20	28	24,0	21,0	8,20	8.500	

CATENA A RULLI FOLLI PER TRASPORTATORI AD ACCUMULO

ACCUMULATIONS CHAINS

TYPE 1

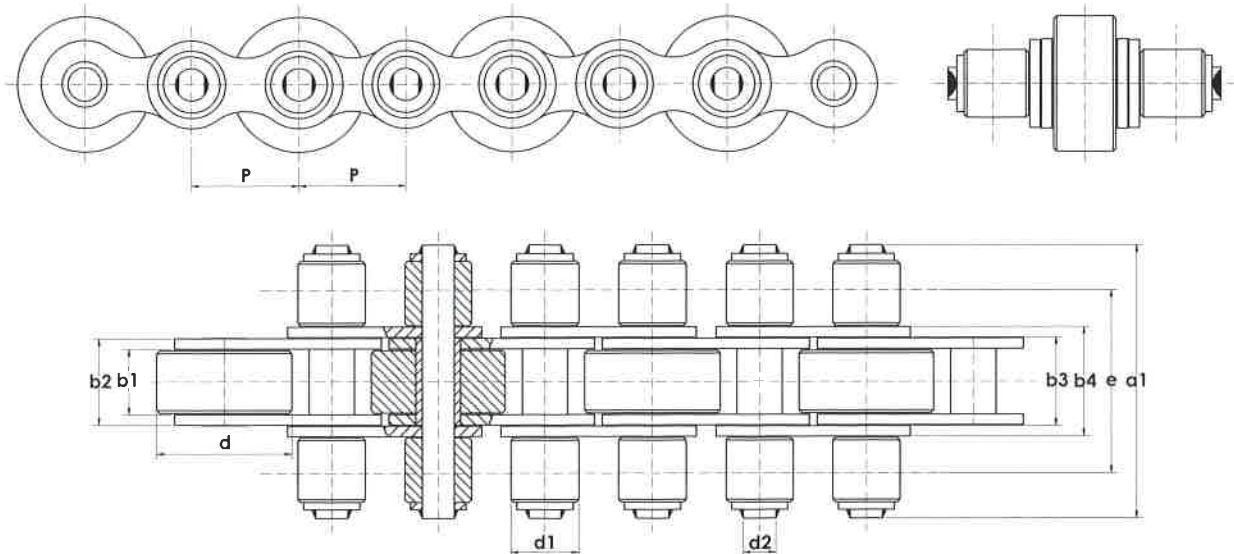

TYPE 2

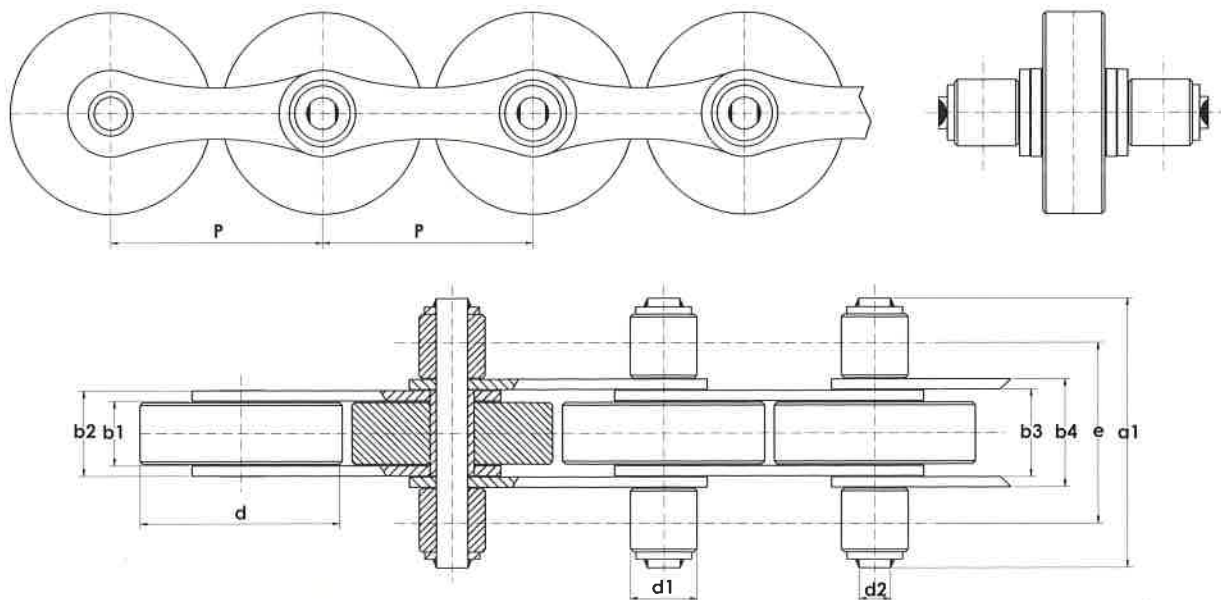

NOSTRO CODICE	Carico minimo di rottura Kg	Peso per metro Kg	p mm	b ₁ mm	b ₂ mm	b ₃ mm	b ₄ mm	d mm	d ₁ mm	d ₂ mm	e mm	a ₁ mm	TRADE MARK
516SRS/ACC (type 1)	1.900	1.505	12,70	7,75	10,8	11,0	14,2	17,0	8,51	4,45	20,2	30,0	
716SRS/ACC (type 1)	3.200	3.100	19,05	11,70	15,6	15,8	19,5	24,0	12,07	5,72	31,5	48,0	
716BOSCH/ACC (type 1)	3.200	2.870	19,05	11,70	15,6	15,8	19,5	26,0	12,00	5,72	29,5	42,0	
143SRS/ACC (type 1)	6.500	7.200	25,40	17,00	25,4	25,8	32,0	38,5	15,88	8,28	44,9	67,9	
1003SRS/ACC (type 2)	3.200	2.600	38,10	11,70	15,6	15,8	19,5	24,0	12,00	5,72	31,5	48,0	
1004SRS/ACC (type 2)	6.500	7.600	50,80	17,00	25,4	25,8	32,0	50,0	15,88	8,28	44,9	67,9	

CATENA TRIPLA CON RULLO FOLLE LATERALE

TRIPLE CHAIN WITH LATERAL FLY ROLLER

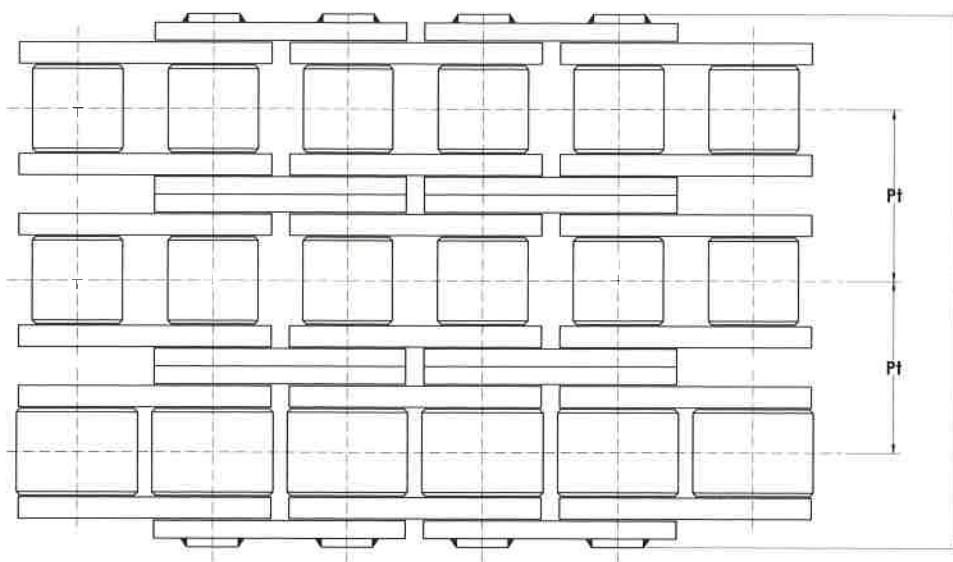
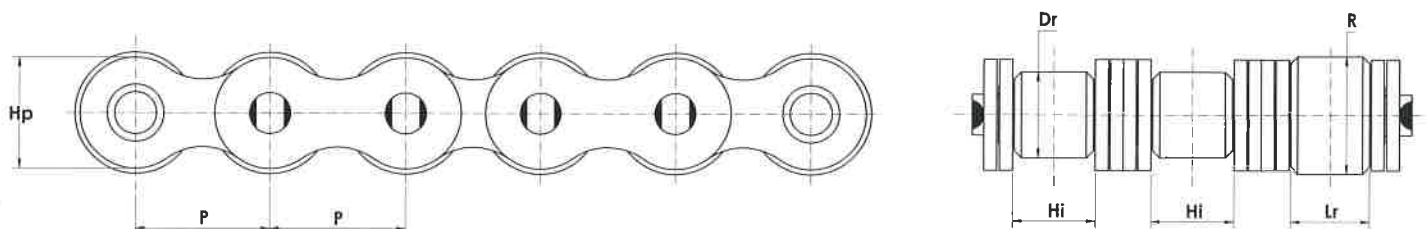

NOSTRO CODICE	passo	largh. interna	diam. rullo	altezza piastra	ingombro perno	passo trasversale	diam. rullo folle	larghezza rullo folle	Carico minimo di rottura Kg	TRADE MARK
	P mm	Hi mm	Dr mm	Hp mm	l mm	Pt mm	R mm	Lr mm		
716RE/ACC	19,05	11,68	12,07	16,13	62,0	19,46	18	11,0	6.000	
143RE/ACC	25,40	17,02	15,88	21,0	99,0	31,88	22	16,5	12.000	

CATENE CON RULLO FOLLE LATERALE

CHAINS WITH LATERAL FLY ROLLER

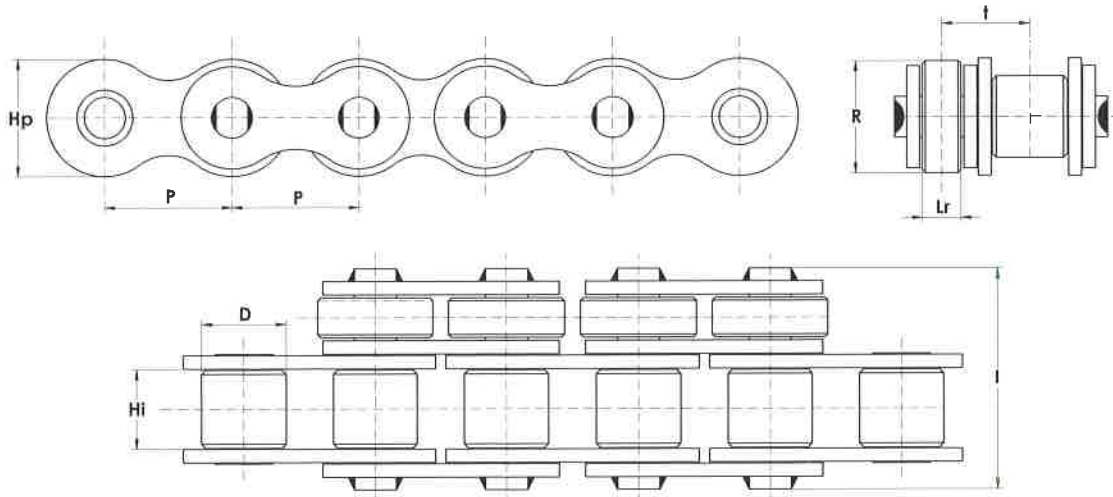

NOSTRO CODICE	passo	largh. interna	diam. rullo	altezza piastra	ingombro perno	interasse orizzontale	diam. rullo folle	larghezza rullo folle	Carico minimo di rottura Kg	TRADE MARK
	P mm	Hi mm	Dr mm	Hp mm	l mm	t mm	R mm	Lr mm		
D 1959	15,875	9,65	10,16	14,73	26,60	11	14	5	2500	

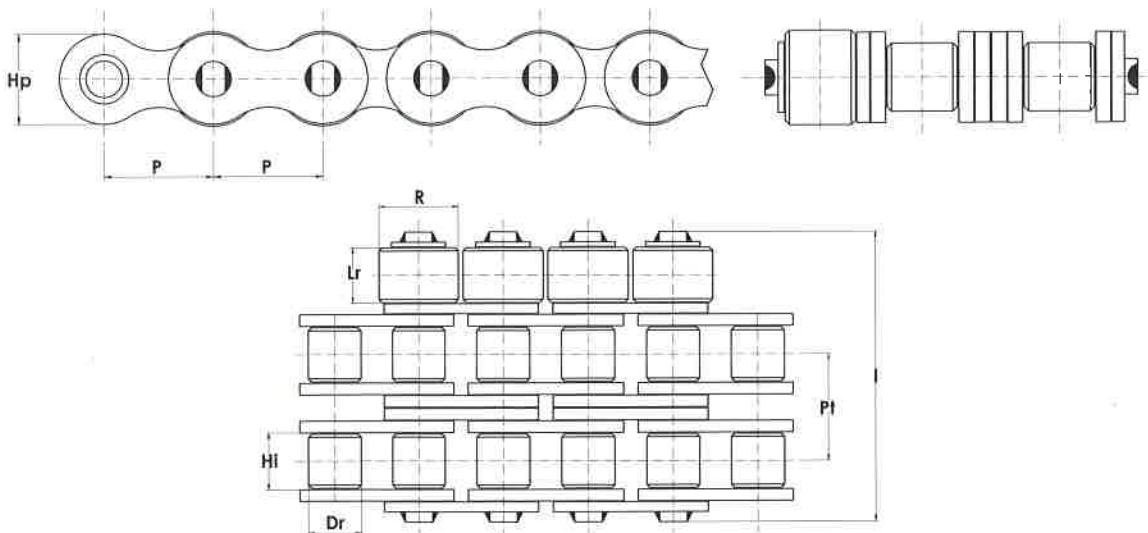

NOSTRO CODICE	passo	largh. interna	diam. rullo	altezza piastra	ingombro perno	passo trasversale	diam. rullo folle	larghezza rullo folle	Carico minimo di rottura Kg	TRADE MARK
	P mm	Hi mm	Dr mm	Hp mm	l mm	Pt mm	R mm	Lr mm		
143SP/ACC	25,4	17,02	15,88	21	88,5	31,88	22	16,5	12.000	

CATENA TRIPLA CON UN RULLO FOLLE LATERALE

TRIPLE CHAIN WITH LATERAL FLY ROLLER

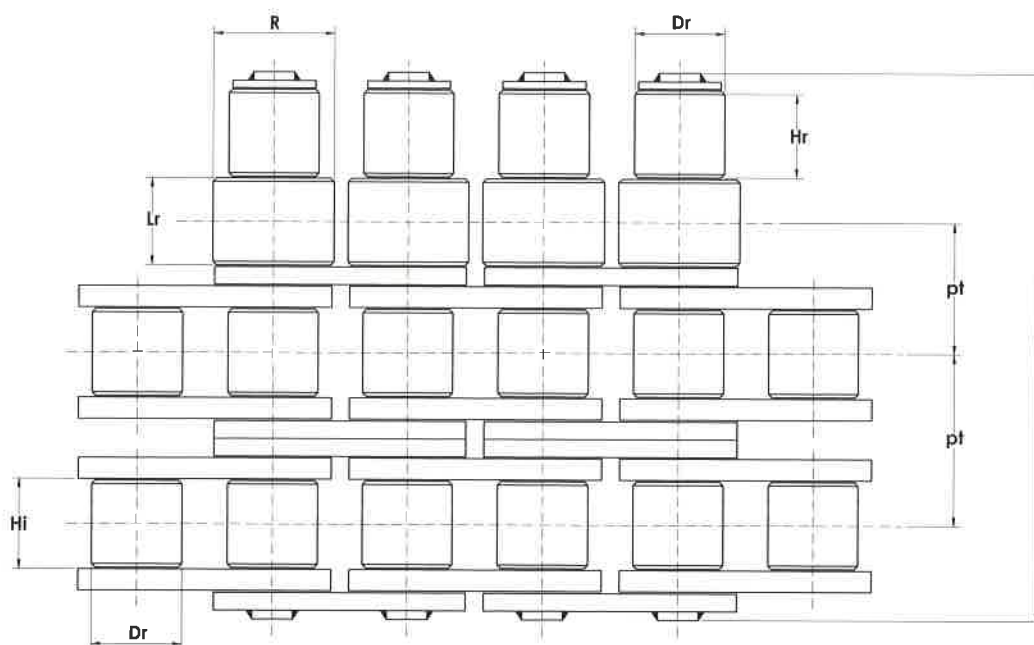
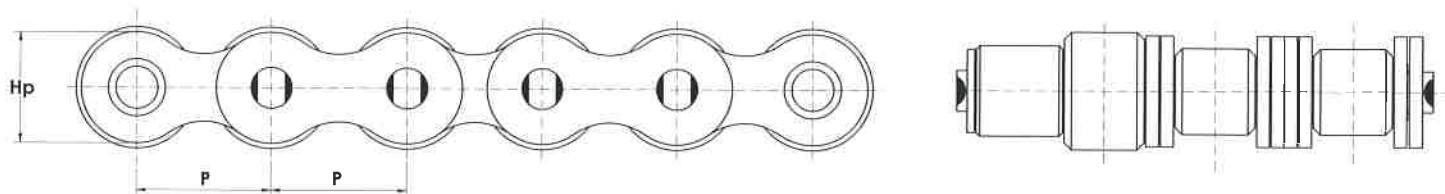

NOSTRO CODICE	passo	largh. interna	diam. rullo	altezza piastra	ingombro perno	passo trasversale	diam. rullo folle	larghezza rullo folle	larghezza rullo laterale	Carico minimo di rottura	TRADE MARK
	P mm	Hi mm	Dr mm	Hp mm	I mm	Pt mm	R mm	Lr mm	HR mm	Kg	
143AI/ACC	25,40	17,02	15,88	21	101,5	31,88	22	16,5	16,5	12.000	

PARTI STACCATE PER CATENE A RULLI
LOOSE PARTS FOR ROLLER CHAINS

N°40	semplice single			multipla multiple	N°35	semplice single			multipla multiple
	MAGLIA INTERNA ROLLER LINK					MAGLIA ESTERNA PINK LINK			
N°21	semplice single			multipla multiple	N°20	semplice single			multipla multiple
	GIUNTO CON COPIGLIE COTTER CONNECTING LINK					GIUNTO CON MOLLETTA SPRING CLIP CONNECTING LINK			
N°26	semplice single			perno giunto connecting pin	N°27	semplice single			perno giunto connecting pin
	GIUNTO CON DADO PER PERNI FORATI NUT CONNECTING LINK FOR HOLLOW PINS					GIUNTO CON SEEGER PER PERNI FORATI SEEGER CONNECTING LINK FOR HOLLOW PINS			
N°30	semplice single			multipla multiple	N°31	semplice single			multipla multiple
	MAGLIA FALSA DOPPIA OFFSET SECTION					MAGLIA FALSA CON COPIGLIE ROLLPIN OFFSET LINK			
N°22				COPIGLIA COTTER	N°25				
	PERNO GIUNTO CONNECTING PIN					MOLLETTA SPRING CLIP		DADO NUT	SEEGER SEEGER

La Società **ROSA CATENE** spa ed **EUROCATENE** sas sono presenti con i loro prodotti anche nei seguenti settori:

Richiedete alla nostra sede i cataloghi di Vostro interesse

AGRICOLTURA



TRASPORTO GOMMA



CATENE PER ACCUMULO



TRASPORTO LEGGERO



CATENE RASCHIANTI



TRASPORTO PESANTE



TRASMISSIONE



TRAZIONE



ROSA
EURO
CATENE

FABBRICA CATENE AGRICOLE E INDUSTRIALI
INDUSTRIAL AND AGRICULTURAL CHAIN FACTORY

Via S. Rocco, 5/B - 23801 **CALOLZIOCORTE** (LC) - Italy
Tel. 0039.0341.630.294 - Telefax Italy 0039.0341.631.139 - Telefax Foreign.0039.0341.645.789
www.rosacatene.com - e-mail: rosa@rosacatene.com